

23HS SERIES 1.8°

Key Features

- High Torque
- High Accuracy
- Smooth Movement



General Specifications

- Bi-polar

Series & Length	Model Number	Holding Torque		Rated Current	Resistance per Phase	Inductance per Phase	Detent Torque		Rotor Inertia	
		mNm	oz-in	A	ohm	mH	mNm	oz-in	g.cm ²	oz-in ²
23HS0 41 mm (1.61 in.)	23HS0030	550	77.95	2.1	1.0	2.3	22	3.12	135	0.74
	23HS0036	550	77.95	1.5	1.6	4.4				
23HS4 45 mm (1.77 in.)	23HS4008	880	124.7	3	0.65	1.68	28	3.96	180	0.99
	23HS4009	880	124.7	2.1	1.7	4.2				
23HS1 50 mm (1.97 in.)	23HS1033	900	127.6	1.5	2.5	7.5	32	4.53	220	1.21
	23HS1034	900	127.6	2.1	1.5	3.7				
23HS2 54 mm (2.13 in.)	23HS2067	1100	155.9	1.5	3.3	10.2	40	5.66	260	1.43
	23HS2068	1100	155.9	2.1	2	7				
23HS3 76 mm (2.99 in.)	23HS3001-09	1900	269.3	1.5	4.2	18.5	70	9.91	460	2.53
	23HS3027-07	1900	269.3	3	1	3.4				
	23HS3045	1650	233.8	2.1	2	8.45				
23HS5 111 mm (4.37 in.)	23HS5402-08*	3200	453.5	6	0.5	2.1	120	16.99	750	4.13
	23HS5408*	3200	453.5	3	1.9	8.5				

* Lead wire connecting type

- Uni-polar

Series & Length	Model Number	Holding Torque		Rated Current	Resistance per Phase	Inductance per Phase	Detent Torque		Rotor Inertia	
		mNm	oz-in	A	ohm	mH	mNm	oz-in	g.cm ²	oz-in ²
23HS0 41 mm (1.61 in.)	23HS0007-25	470	66.61	2.1	1.4	1.6	22	3.12	135	0.74
	23HS0030-02	470	66.61	1.5	2	2.1				
23HS1 50 mm (1.97 in.)	23HS1026	850	120.5	2.1	1.6	2.5	32	4.53	220	1.21
	23HS1035	850	120.5	1.5	2.75	4				
23HS2 54 mm (2.13 in.)	23HS2005-06	950	134.6	2.1	1.9	3.2	40	5.66	260	1.43
	23HS2069	950	134.6	1.5	3.4	5.5				
23HS3 76 mm (2.99 in.)	23HS3004-15	1500	212.6	3	1	2.2	70	9.91	460	2.53
	23HS3045-03	1500	212.6	1.5	4	8.2				

- Wiring Connection, Lead Wires, Schematic Diagrams & Stepping Sequence.....Page 62 - 64

Mechanical Dimension

Series	L	Mass
	mm (in.)	kg (lb.)
23HS0	41 (1.61)	0.42 (0.93)
23HS4	45 (1.77)	0.48 (1.06)
23HS1	50 (1.97)	0.55 (1.21)
23HS2	54 (2.13)	0.60 (1.32)
23HS3	76 (2.99)	1.00 (2.20)
23HS5	111 (4.37)	1.50 (3.30)

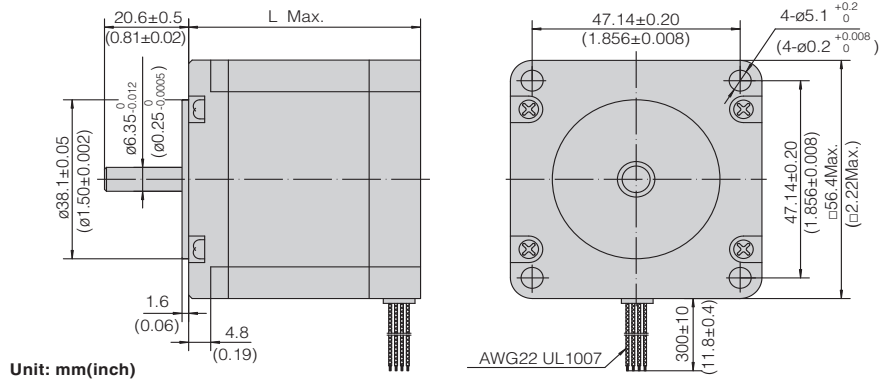
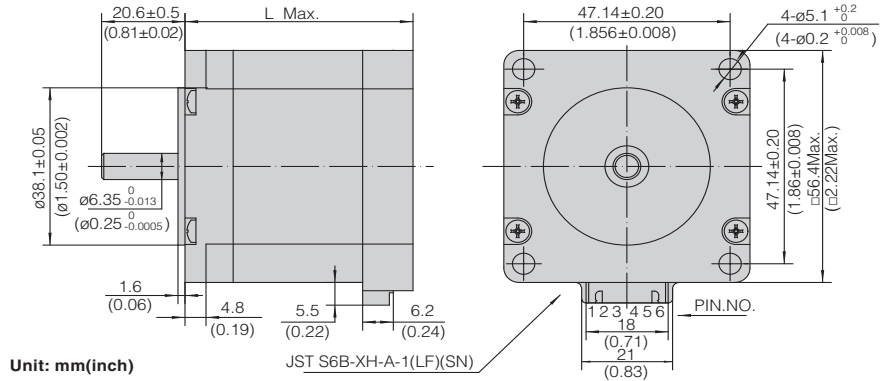

Dynamic Torque Curves

- Bi-polar

23HS0030

Conditions: Bi-polar Constant Current Driver
 Driver: AMA MS3540M
 Mode: Full Step

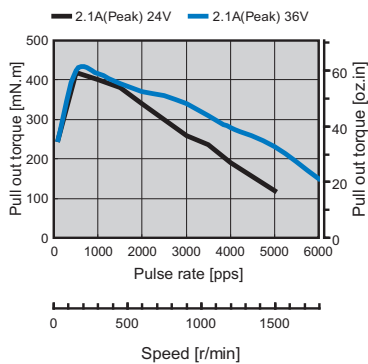

23HS0036

Conditions: Bi-polar Constant Current Driver
 Driver: AMA MS3540M
 Mode: Full Step

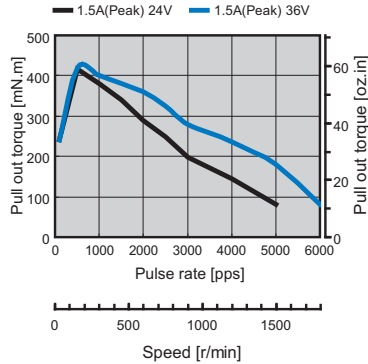

23HS4008

Conditions: Bi-polar Constant Current Driver
 Driver: AMA MS3540M
 Mode: Full Step

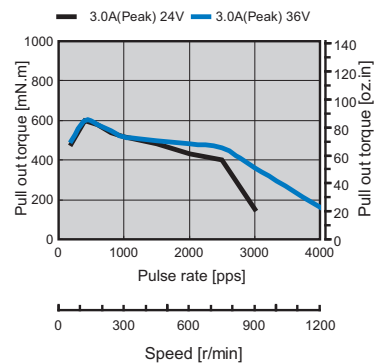

Dynamic Torque Curves

• Bi-polar

23HS4009

Conditions: Bi-polar Constant Current Driver
Driver: AMA MS3540M
Mode: Full Step

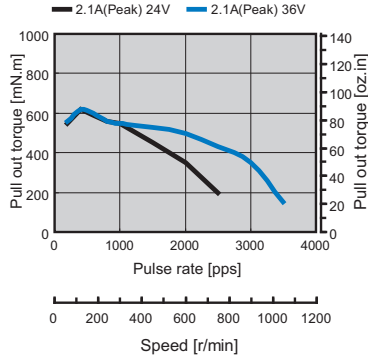

23HS1033

Conditions: Bi-polar Constant Current Driver
Driver: AMA MS3540M
Mode: Full Step

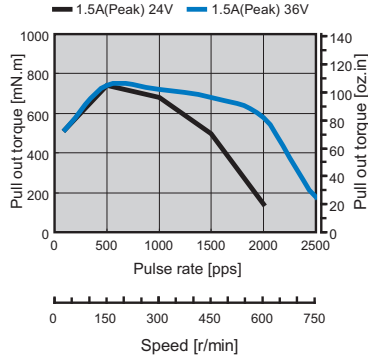

23HS1034

Conditions: Bi-polar Constant Current Driver
Driver: AMA MS3540M
Mode: Full Step

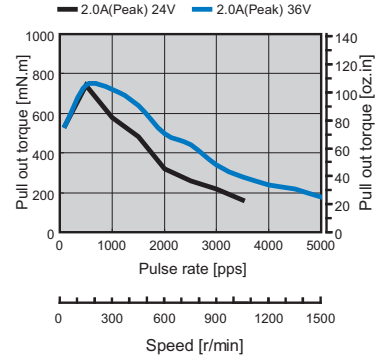

23HS2067

Conditions: Bi-polar Constant Current Driver
Driver: AMA MS3540M
Mode: Full Step

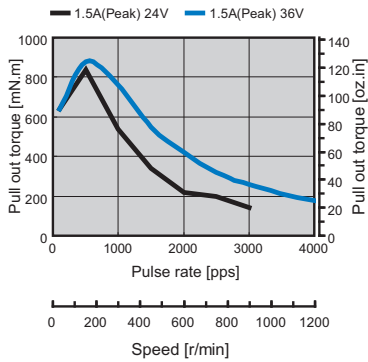

23HS2068

Conditions: Bi-polar Constant Current Driver
Driver: AMA MS3540M
Mode: Full Step

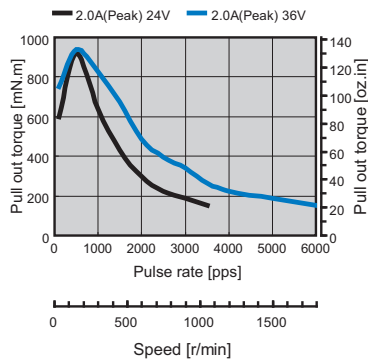

23HS3001-09

Conditions: Bi-polar Constant Current Driver
Driver: AMA MS3540M
Mode: Full Step

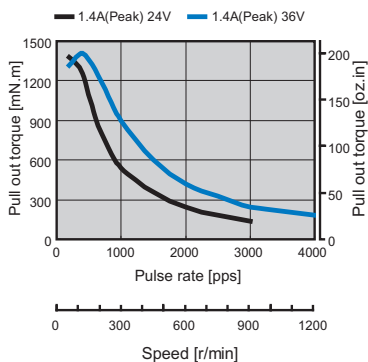

23HS3027-07

Conditions: Bi-polar Constant Current Driver
Driver: AMA MS3540M
Mode: Full Step

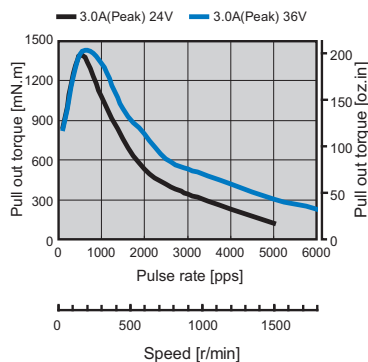

23HS3045

Conditions: Bi-polar Constant Current Driver
Driver: AMA MS3540M
Mode: Full Step

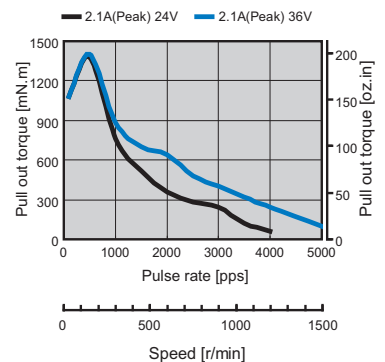

Dynamic Torque Curves

- Bi-polar

23HS5402-08

Conditions: Bi-polar Constant Current Driver
 Driver: AMA MS3540M
 Mode: Full Step

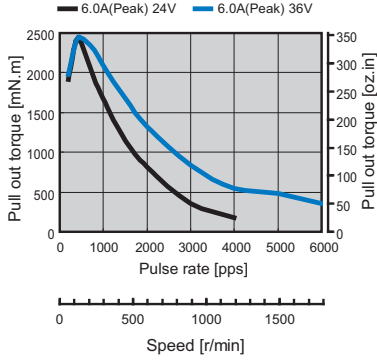

23HS5408

Conditions: Bi-polar Constant Current Driver
 Driver: AMA MS3540M
 Mode: Full Step

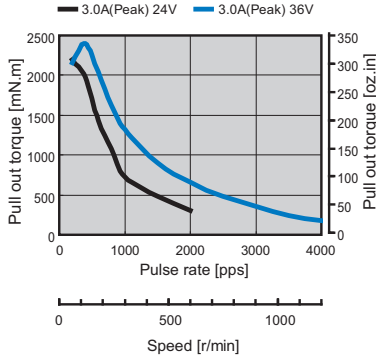

- Uni-polar

23HS0007-25

Conditions: Uni-polar Constant Current Driver
 Driver: AMA MSU3040M
 Mode: Full Step

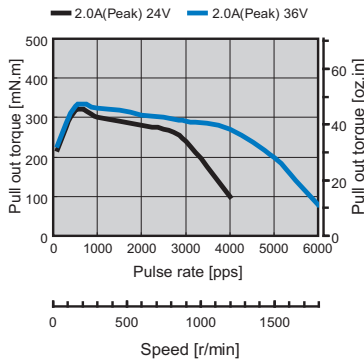

23HS0030-02

Conditions: Uni-polar Constant Current Driver
 Driver: AMA MSU3040M
 Mode: Full Step

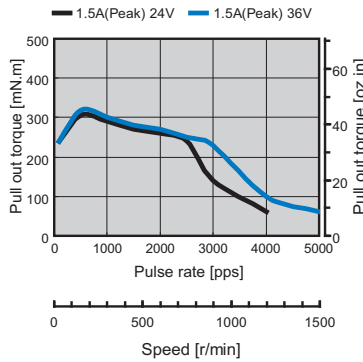

23HS1026

Conditions: Uni-polar Constant Current Driver
 Driver: AMA MSU3040M
 Mode: Full Step

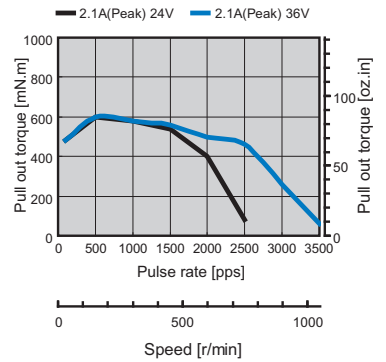

23HS1035

Conditions: Uni-polar Constant Current Driver
 Driver: AMA MSU3040M
 Mode: Full Step

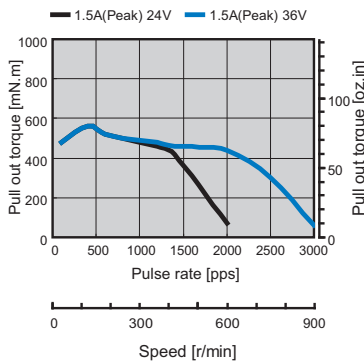

23HS2005-06

Conditions: Uni-polar Constant Current Driver
 Driver: AMA MSU3040M
 Mode: Full Step

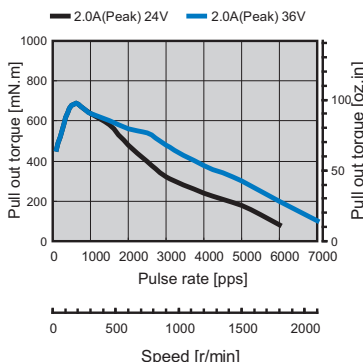

23HS2069

Conditions: Uni-polar Constant Current Driver
 Driver: AMA MSU3040M
 Mode: Full Step

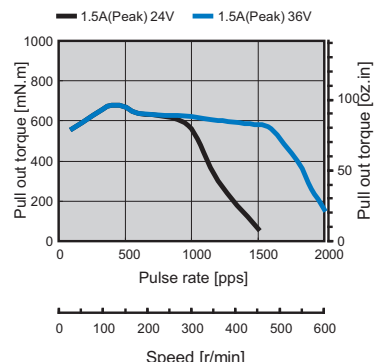

Dynamic Torque Curves

- Uni-polar

23HS3004-15

Conditions: Uni-polar Constant Current Driver
Driver: AMA MSU3040M
Mode: Full Step

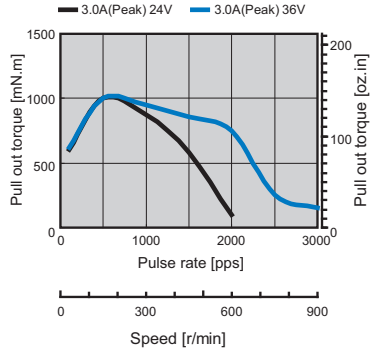

23HS3045-03

Conditions: Uni-polar Constant Current Driver
Driver: AMA MSU3040M
Mode: Full Step

