



Butternut® HF9V
80/40/30/20/15/17/12/10/6 Meters
Nine-Band
Vertical Antenna

BUT-HF9V

BUT-HF9V-INS-Revision 1b

© Butternut 2016
1200 Southeast Ave. - Tallmadge, OH 44278 USA
Phone: (800) 777-0703 · Fax: (330) 572-3279
Tech Support and International: (330) 572-3200

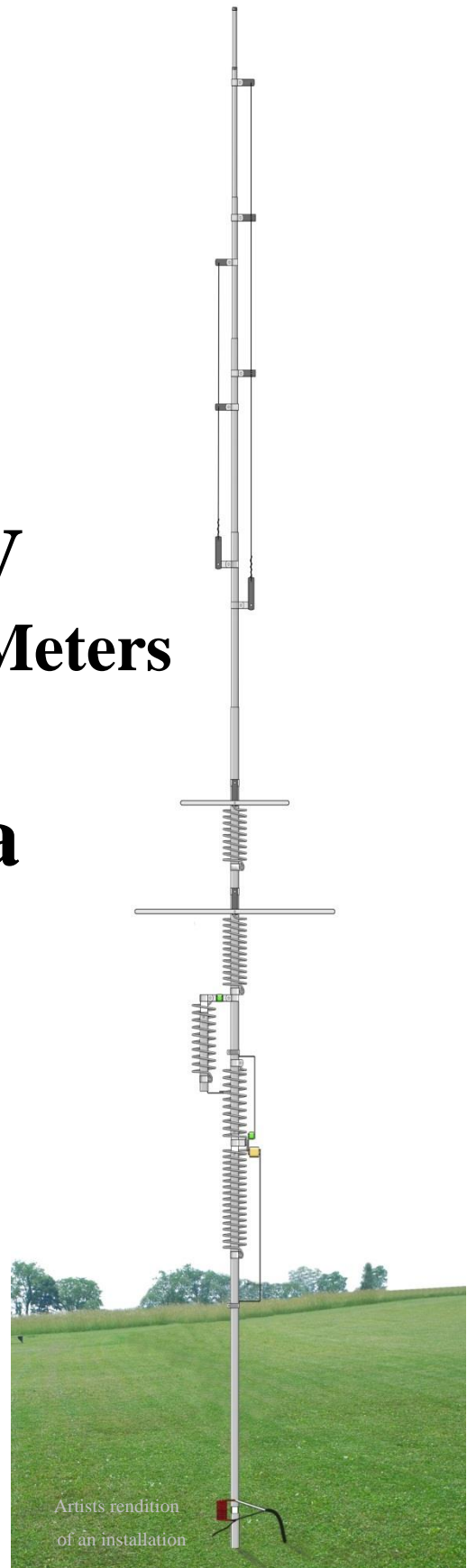

Introduction

The classic Butternut[®] HF9V Nine-band vertical antenna operates on 75/80, 40, 30, 20, 17, 12, 15, 10 and 6 meters. Designed with corrosion-resistant aluminum tubing, 26 feet tall and only a 2.2 ft² wind load, this antenna is very durable and attractive.

Features

- Full band coverage for 80, 40, 30, 20, 17, 15, 12, 10 and 6 meters
- Height is 26 feet
- Weight is only 14 pounds
- Feedpoint Impedance is a nominal 50 ohms through the included matching line
- Power handling: 1,500 W full legal limit on 80/40/20/15/10M
800 W PEP on 17 and 12M
500 W PEP on 30 and 6M
- Wind load 2.2 ft² (80 mph survivability - no ice)
- VSWR at resonance: 1.5:1 to 2.5:1 or less on all bands
- Bandwidth for VSWR 2:1 or less: 30/20/17/15/12/10M - entire band.
- Bandwidth for VSWR 2:1 or less: 140-150 kHz on 40M, 25-30 kHz on 75/80M
- Active Element Lengths: 1/4-wavelength on 80, 40, 30 and 15M
3/8-wavelength on 20M
1/2-wavelength on 17M
5/8-wavelength on 12M
3/4-wavelength on 10, 6M
- **Requires** radial system

WARNING!

INSTALLATION OF ANY ANTENNA NEAR POWER LINES IS DANGEROUS



Warning: Do not locate the antenna near overhead power lines or other electric light or power circuits, or where it can come into contact with such circuits. When installing the antenna, take extreme care not to come into contact with such circuits, because they may cause serious injury or death.

Overhead Power Line Safety

Before you begin working, check carefully for overhead power lines in the area you will be working. Don't assume that wires are telephone or cable lines; check with your electric utility for advice. Although overhead power lines may appear to be insulated, often these coverings are intended only to protect metal wires from weather conditions and may not protect you from electric

shock. Keep your distance! As a suggestion, remember the 10-foot rule; when carrying and using ladders and other long tools, keep them at least 10 feet away from all overhead lines - including any lines from the power pole to your home.

Theory of Operation

The first L/C circuit generates enough reactance to bring the whole HF9V to resonance on 80 meters allowing it to act as an electrical 1/4-wavelength radiator. It also generates enough *capacitive* reactance to produce another discrete resonance at about 11 MHz.

The second, 40 meter L/C circuit generates enough reactance to resonate the whole HF9V allowing it to act as a 1/4-wavelength radiator. In order to minimize conductor and I²R losses on 80 and 40 meters where the antenna is physically shorter than a 1/4-wavelength and thus operates with lower values of radiation resistance, large-diameter self-supporting inductors and low-loss ceramic capacitors are employed. Where the height of the HF9V is slightly greater than a 1/4-wavelength on 30 meters, an L/C series tuned circuit taps onto the 40 meter coil for the extra inductance to pull the earlier 11 MHz secondary resonance down to 10 MHz.

At the same time, a portion of the 40 meter coil is shorted out which allows the circuit to resonate on 30 meters. The addition of this circuit also produces additional resonances at 14 MHz and 28 MHz.

On 20 meters the entire radiator operates as a 3/8-wavelength vertical with much higher radiation resistance and VSWR bandwidth than conventional or *trapped* antennas having a physical height of 1/4-wavelength or less. Because the 20 meter radiation resistance will be several times greater than that of conventional vertical antennas, an electrical 1/4-wavelength section of 75 ohm coax is used as a *geometric mean* transformer to match the approximate 100 ohms of feedpoint impedance on that band to a 50 ohm main transmission line of any convenient length.

The HF9V operates as a slightly extended 1/4-wavelength radiator on 15 meters, a 1/4-wavelength stub decoupler providing practically lossless isolation of the upper half of the antenna on that band. On 10 meters the HF9V becomes a 3/4-wavelength radiator with considerably greater radiation resistance and efficiency than 1/4-wavelength trapped types.

On 17 and 12 meters the coils act as *packets of reactance* which allow the entire radiator to operate as a 1/2-wavelength or 5/8-wavelength vertical. Capacitance for these circuits comes from what exists between the windings, the radiator and the capacitance hat.

On 6 meters the vertical wire, together with the adjacent section of antenna, form a short-circuited 1/4-wavelength transmission line which cancels current flow. At the lower, open end of the 1/4-wavelength section a very high impedance is created the effectively divorces the upper part of the antenna leaving the lower section to radiate as a 3/4-wavelength vertical.

Tools Required

Straight Slot Screwdriver
Phillips Head Screwdriver
1/4" Nut Driver or socket set
11/32" Nut Driver or socket set
3/8" Nut Driver or socket set
Tape measure
Pencil

NOTE: Please read **all** instructions thoroughly **before** proceeding to the assembly.

There are parts made from fiberglass in this kit. Take normal precautions when handling any fiberglass material. There may be fiberglass dust, slivers or particles present when the fiberglass parts were manufactured. The use of typical fiberglass handling safety gear (gloves, dust mask, eye shield, clothing, etc.) when handling and working with fiberglass is recommended. Use a damp rag to wipe the parts. **Do not** use compressed air to clean fiberglass parts. Measures can be taken to reduce exposure after a person has come in contact with fiberglass. Eyes should be flushed with water and any area of exposed skin should be washed with soap and warm water to remove fibers. Clothing worn while working with fiberglass should be removed and washed separately from other clothing. The washing machine should be rinsed thoroughly after the exposed clothing has been washed. Check with your local or state safety and/or environmental agencies for more detailed precautions.

Additional Material Needed But Not Supplied

Jet-Lube™ SS-30 Aniti-Oxidant Corrosion Inhibiting Lubricant

Ground Rod installed near base of the antenna.

Suggested Parts Not Included

NOTE: High performance Butternut[®] Vertical Antennas require a radial system for all installations.

Butternut offers a variety of radial systems for installing with vertical antennas.

Radial Wire Kits and Components - There are optional Butternut Radial Wire Kits available.

Guying Kit for Vertical Antennas - Some vertical antenna manufacturers indicate their antennas do not need guying. During times of high winds or ice loading, some of these vertical antennas may sustain damage or fail altogether. With the small amount of effort needed to install a four point guying system, the risk hardly seems worth taking. A four-point guying scheme provides the best mechanical advantage to reduce wind stress, regardless of direction. Information on guying the Butternut[®] HF9V is included in this manual. Information on guying the Butternut[®] HF9V can be found in the section “*Guying the HF9V Antenna*”.

BUT-GRK Ground Radial Kit for ground mounting - 160 thru 6 meter operation

BUT-RMK-II Roof Mounting Kit for roof mounting - 80 thru 6 meter operation

Site Selection

Ideally, select a mounting location clear from power lines, structures and other antennas by a minimum of 45 feet. **Consider overhead power lines, utility cables and wires.**

The vertical should be mounted away from local noise sources or other metallic objects which can re-radiate noise and affect the tuning, radiation pattern and SWR.

Determine the direction you want the antenna to tilt down and make sure there is adequate clearance (at least 45 feet). There should also be a clear diameter of 70 to 130 feet from the antenna for the guying and radial systems that will extend away from the antenna.

As with all Amateur Radio antennas there maybe compromises and the ideal site may not be available.

Mounting Tube (A) Installation

When the bottom tube with insulator (A) is ground mounted, it should be protected against corrosion if placed in concrete, damp acidic or alkaline soil. Asphalt roofing compound, polyurethane varnish or other sealant that protects against moisture may be used. Concrete may be used in areas of high winds for greater strength, in which case the post may be twisted slightly during setting for easy removal later. Ensure it is not mounted at an angle. You want the antenna to be vertical when fully installed. To help maintain the antenna base, place a larger diameter metal tube, such as the **BUT-MPS** Mounting Post Sleeve in the ground, then you can slip tube w/insulator (A) in and it will be protected from direct contact with the concrete.

Tube with insulator (A) must be installed in a hole approximately 21" deep so that the upper end of the fiberglass insulator is approximately 7" above ground level. Pack earth tightly around tube w/insulator (A) so that it remains vertical. When installed, you want the top of **tube A** at 2-3" or less above ground level to keep the feedpoint below 5" above ground level.

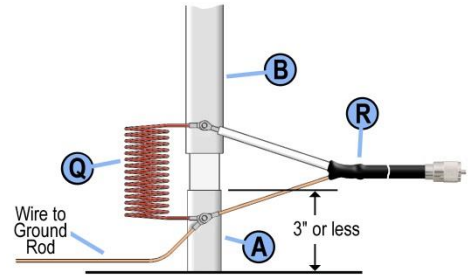

NOTE: HAMMERING TUBE W/INSULATOR (A) INTO THE EARTH MAY CAUSE THE INSULATOR TO SPLINTER. If the post must be hammered into the earth, protect the end of the insulator with a block of wood

NOTE: DO NOT USE U-BOLTS TO ATTACH TUBE W/INSULATOR (A) TO A MAST, TOWER ETC. WITHOUT ADDED PROTECTION. U-BOLTS WILL EVENTUALLY CUT INTO THE TUBING AND WEAKEN THE INSTALLATION. If U-bolts are used, place a larger diameter metal tube, such as the **BUT-MPS** Mounting Post Sleeve over tube w/insulator (A). Similar precautions should be observed when using TV style towers with locking bolts.

The **BUT-RMK-II** Roof Mounting Kit includes the **BUT-MPS** as well as the **BUT-STR-II** Stub Tuned Radial Kit.

Radial System

The use of a radial system is a key requirement for any high performance quarter wave vertical antenna system. **With any vertical antenna system, the radials are the second half of the antenna. The radials contribute to the radiation efficiency of the entire vertical antenna system.**

The exact number of radials required for low SWR and reasonably efficient operation will depend in large measure on local earth conductivity, and this may vary considerably from one place to the next and from one frequency band to the next. For most installations the soil conditions will be poor to very poor when it comes to conductivity.

The best procedure is to assume that most earth is a poor conductor over the HF range and that some radial wires will be needed. Radials may be placed on the surface of the earth or buried slightly below the surface to get them out of the way, and their length is largely a matter of

convenience. In general, a large number of short radials are preferable to a small number of longer radials for a given amount of wire, especially if fewer than a dozen radials are to be used. Unlike resonant radials that must be cut to the proper lengths for use with elevated verticals, ground-level radials need not to be cut to any particular length; their sole purpose is to provide less lossy return paths for currents flowing along the earth than the earth itself can provide. And, since "return" currents will be flowing back to the antenna from all points of the compass, the radial wires should be spaced uniformly over 360 degrees, although physical circumstances will often make this "ideal" distribution impossible. For a discussion of ground system for elevated verticals, see the section entitled "Above Ground Installations" following Checkout and Adjustment instructions.

At a minimum, 20 radials, each 32 feet long, may be used with this antenna. Using 32 radials at 65 feet long are preferred and highly recommended for the best performance on 80 meters with this antenna. The extra radials help overcome unknown poor-soil conditions, improve bandwidth, and ensure the best performance efficiency possible from the Butternut[®] HF9V antenna. Radial Wire, a 14 gauge stranded copper with black relaxed PVC insulation wire is suggested for the best results for ease of installation and being able to withstand foot traffic over the radial wires without breaking smaller gage wires.

The wire radials should be placed as symmetrically as possible straight from the feedpoint around the vertical antenna and spaced evenly, regardless of how many radials are used. Do not cross or bunch any radial wires as this nullifies their effectiveness. If you have limited space, put in as many straight radials as you can. The radials must be connected to the shield of your feedline. A Stainless Steel Radial Plate is the ideal optional item which provides an excellent system for attaching radial wires to your vertical antenna system.

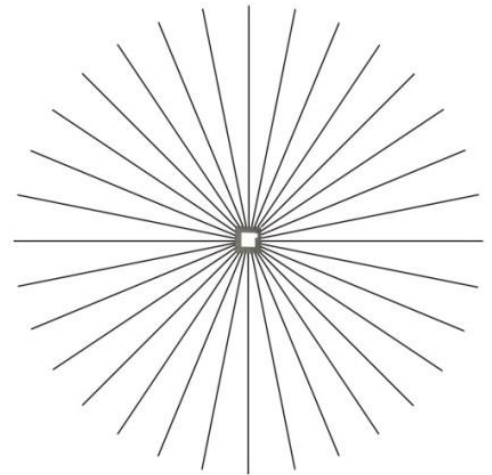

Radial wires can be laid on the roots of the grass or on bare ground using Radial Wire Anchor Pins to hold them down. Using enough staples will ensure the wires will not be snagged by mowers, people, or animals. Depending on where you live and the type of grass you have, grass will quickly overgrow the radials and it will be virtually impossible to see them. An article describing this process is available on the Butternut website. Radials can also be buried just under the surface (approximately 1" - anything deeper and you will start losing effectiveness) by using a power edger to make a slit in the soil.

NOTE: The function of a ground rod is to place the antenna at dc ground potential. It cannot take the place of an effective RF ground system, such as a number of radial wires, regardless of its depth in the earth. It does, however, serve as a convenient tie-point for such radials, as does the bolt through mounting post w/insulator (A) to which radials can be connected by means of the remaining #8 hardware.

The Optional Butternut Radial Plate

A Stainless Steel Radial Plate is an ideal option for the radial system that is needed for the Butternut[®] HF9V vertical antenna. The radial plate can be set on the ground. When the antenna is installed, run a short piece of copper strap from the radial plate to the lower connection of coil Q mounted on tube (A) of the HF9V or mounted on the antenna base if the optional **BUT-MPS** Mounting Post Sleeve is used. In either case, a ground wire attachment from the lower tube (A) to the Radial Plate should be made to ensure a good RF connection. This is the same stainless steel Radial Plate that is used on all Butternut vertical antennas and has proven itself to be an enhancement that really works for vertical antenna systems.

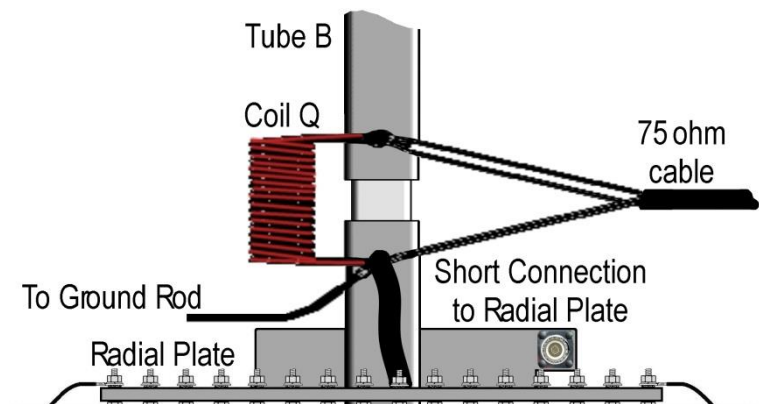

Optional Radial Plate shown installed.

Aluminum Tubing Information

When assembling any telescoping aluminum tubing sections you should take the following steps:

1. Make sure the edges are smooth and not sharp. Deburring may be necessary, since burrs and shavings can occur on seams as well as edges. All surfaces need to be completely smooth to allow easy assembly of tubing sections.

Caution

*Aluminum tubing edges can be very sharp.
Take precautions to ensure you do not get accidentally cut.*

The raised particles and shavings that appear when the aluminum tubing is machined are referred to as burrs, and the process by which they are removed is known as deburring.

Butternut aluminum tubing is machine cut on both ends and machine slit on one end.

2. Clean the inside of the aluminum tubing to clear out any dirt or foreign material that would cause the aluminum tubing sections to bind during assembly. Do not use any type of oil or general lubricant between the aluminum tubing sections. Oils or general lubricants can cause poor electrical connections for radio frequencies.
3. Clean the outside of the aluminum tubing to clear any dirt or foreign material that would cause the clamps to malfunction during assembly.
4. The use **Jet-Lube™ SS-30 Pure Copper Anti-Seize** is highly recommended. Jet-Lube™ SS-30 is an electrical joint compound which effects a substantial electrical connection between metal parts such as telescoping aluminum tubing or other antenna pieces. Using Jet-Lube™ SS-30 assures high conductivity at all voltage levels by displacing moisture and preventing corrosion or oxidation.
5. When assembling the aluminum tubing sections, ensure the area is clear of grass, dirt or other foreign material that could cause problems during assembly of the closely fitted telescoping sections.

Assembly

Note: For reference, a completed **HF9V Antenna** is shown at the end of this manual following the detailed parts list.

*Note: **Jet-Lube™ SS-30 Anti-Oxidant** should be used between all antenna element sections. Jet-Lube™ SS-30 is an electrical joint compound to affect a substantial electrical connection between metal parts such as **telescoping aluminum tubing** or other antenna pieces. It ensures high conductivity at all voltage levels by displacing moisture and preventing corrosion or oxidation.*

*Jet-Lube™ SS-30 should also be used on all **coil clamps, element clamps, bolts and stainless steel threaded hardware** to provide good electrical contact, prevent galling, allow easier disassembly and to ensure proper tightening.*

1. Check to be sure that no parts are missing (see assembled antenna pictorial page)
2. If the antenna is to be installed at ground level, install mounting tube (A) in a hole approximately 21 inches deep so the upper end of the fiber rod insulator (feedpoint connection) is approximately 3 inches or less above ground level. **Ensure it is not mounted at an angle.** You want the antenna to be vertical when fully installed.



Pack earth tightly around mounting tube (A) so that it will remain vertical. Concrete may be used in areas of high wind for greater rigidity, in which case the mounting tube should be rotated while the concrete is setting so that it may be easily removed later. If the antenna is to be mounted in concrete or in damp, acidic or alkaline soil, the mounting tube should be given a protective coating of asphalt roofing compound, polyurethane varnish, or another suitable covering to protect the metal against corrosion. You may also want to use the optional **BUT-MPS** Mounting Post Sleeve which fits over tube (A) to help protect it from contamination.



NOTE: DO NOT HAMMER THE MOUNTING POST INTO THE GROUND AS THIS CAN SPLINTER THE FIBER ROD INSULATOR AND COMPLICATE INSTALLATION.

Note: Step 3 starts the antenna assembly minus Tube A (with insulator). The antenna assembly will be mated to tube (A) when ready to be installed for final assembly steps. In all subsequent steps, assembly should be done indoors or in an area where dropped hardware may easily be recovered.

3. Locate Tube (B) and (B1). Slide the insulator on tube (B1) into the top of tube section (B) and secure with a #8 x 1-1/2" bolt, #8 lock washer and #8 hex nut.



Tube (B) 1-1/8" x 48" long



Tube (B1) 1-1/8" x 12" with insulator

NOTE: Tube (B) has the mounting hole located 1/4" from the end.



CAUTION: IF A FLAT BLADE SCREWDRIVER IS USED - NEVER HOLD THE WORK OPPOSITE THE BLADE IN ORDER TO AVOID POSSIBLE INJURY IN CASE THE BLADE SLIPS

- From the center of the insulator, measure downward to a point that is 13" along tube (B) and make a pencil mark.



- From the center of the insulator, measure upward to a point that is 9-3/8" along tube (B1) and make a pencil mark.



*Note: **Jet-Lube™ SS-30 Anti-Oxidant** should be used on all **coil clamps, element clamps, bolts and stainless steel threaded hardware** to provide good electrical contact, prevent galling, allow easier disassembly and to ensure proper tightening.*

- Locate coil assembly 80/40 meter (C) and slide the clamp at the outer end of the larger 80 meter coil over tube (B1), lowering the entire assembly until the middle clamp can be positioned around the insulator between tube (B) and tube (B1). NOTE: The middle clamp may have to be pulled open slightly to pass the bolt that goes through tube (B1) and the insulator.



- Position the center coil clamp of coil assembly 80/40 meter (C) in the center of the insulator between tube (B) and tube (B1). Pass a #10 x 1" screw through the clamp as shown. Secure with a flat washer, lock washer and wing nut. NOTE: The outer tab of this clamp may be bent back slightly to provide clearance for the bolt, bending it back into place after assembly.

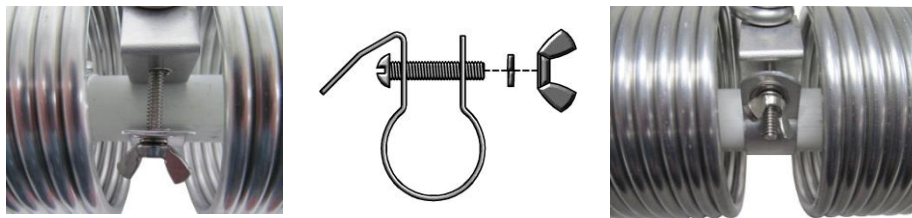

- Stretch the 40 meter (smaller) coil on the coil assembly 80/40 meter (C) until the top of the upper clamp is even with the upper mark. Secure with a #10 flat washer, lock washer and wing nut.



- Stretch the 80 meter (larger) coil on the coil assembly 80/40 meter (C) until the bottom of the lower clamp is even with the lower mark. Secure with a #10 flat washer, lock washer and wing nut.



- Locate the capacitor assembly 80/40 meter (D) and install capacitor bracket 80 meter (D1) on the larger 200 pF capacitor using the installed screw.



NOTE: DO NOT USE EXCESSIVE FORCE OR OVER TIGHTEN THE SCREWS ON EITHER CAPACITOR AS YOU WILL DAMAGE THEM. DO NOT DROP THIS ASSEMBLY AS YOU MAY FRACTURE THE CAPACITOR'S CERAMIC SHELL.

- Locate capacitor bracket 40 meter (D2) and install on the smaller 67 pF capacitor as shown.



- Install the above assembly onto the #10 screw protruding from the tab of the center clamp on the coil assembly 80/40 meter (C). Align capacitor bracket 80 meter (D1) alongside the larger 80 meter coil of coil assembly 80/40 meter (C). Secure with a #10 flat washer, lock washer and hex nut.



- Attach the tab end of capacitor bracket 80 meter (D1) to tube (B) with capacitor bracket clamp (U) and secure with # 8 x 1" screw, lock washer and a hex nut.



- Attach the tab end of capacitor bracket 40 meter (D2) to tube (B1) with capacitor bracket clamp (U) and secure with # 8 x 1" screw, lock washer and a hex nut.

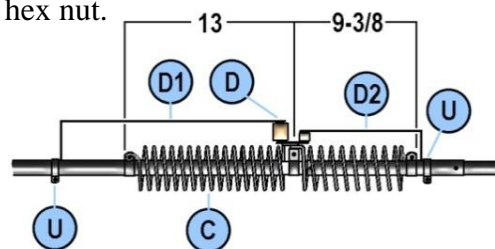

15. Insert the un-slotted end of tube (E) into tube (B1) and secure with a # 8 x 1-1/2" screw, lock washer and hex nut.



16. Locate coil support tube 30 meter (O) and measure to a point 9-7/8" down from the end of the plastic insulator. Mark this point with a pencil.



17. Locate coil support tube 30 meter L bracket (O1) and place the tabbed end inside of the coil support tube 30 meter (O) securing it with a # 8 x 3/4" screw, lock washer and hex nut.



18. Place a #10 washer, lock washer and wing nut on the lower single clamp of coil/capacitor assembly 30 meter (P).

19. Place a #10 washer, lock washer and hex nut on both upper clamps of coil/capacitor assembly 30 meter (P).

20. Pass the lower single clamp of coil/capacitor assembly 30 meter (P) over the insulator end of coil support tube 30 meter (O) and slide the coil downward along the tube until the upper edge of the upper clamp is flush with the end of the insulator. Align the upper clamp with the coil support tube 30 meter L bracket (O1) and tighten the hex nut.



21. Stretch the coil until the bottom of the bottom clamp on the coil/capacitor assembly 30 meter (P) is even with the 9-7/8" mark on coil support tube 30 meter (O) and tighten the wing nut.



22. Slide the remaining clamp from the above assembly over tube (E) and position it so the coil support tube L bracket (O1) is even with fourth turn, counting from the top of the 40 meter coil on the coil assembly 80/40 meter (C) and tighten the hex nut.

23. Hook the 30M coil support tube L-bracket (O1) around the fourth turn of the 40 meter coil on coil assembly 80/40 meters (C). Secure with a # 8 x 3/4" screw, lock washer and hex nut.

24. Attach the 17M strip (X) to the bolt that fastens the coil to the plastic insulator between the coil and the upper clamp of the 17M coil assembly A-17-12 (W). Use the attached flat washer, lock washer and hex nut.

25. Attach the 12M strip (Z) to the 12M coil assembly A-17-12 (Y). Use the attached flat washer, lock washer and hex nut.

26. Loosen the #10 hex nut on the bottom clamp and the wing nut on the upper clamp of the 17M coil assembly A-17-12 (W) and slide the assembly over the upper end of tube (E) with the insulator end up.

27. Slide the unit down until the lower clamp of the 17M coil assembly A-17-12 (W) rests on the upper clamp of the coil/capacitor assembly 30 meter (O).

28. Tighten the hex nut and stretch the coil so that the distance between the upper edge of the lower clamp and the lower edge of the upper clamp is 10-1/2".

29. Install the 12M coil assembly A-17-12 (Y) in the same way, so the lower edge of the lower clamp is about 2" above the upper clamp of the 17M coil assembly A-17-12 (W). This distance is not critical. Note: The 12M coil **MUST** be compressed as much as possible upon initial tuning. If not, it is highly probably that 12M will actually be tuned into 10M throwing the ability to tune 10M at all.

30. Tighten the hex nut and stretch the coil so that the distance between the upper edge of the lower clamp and the lower edge of the upper clamp is 8-3/4".

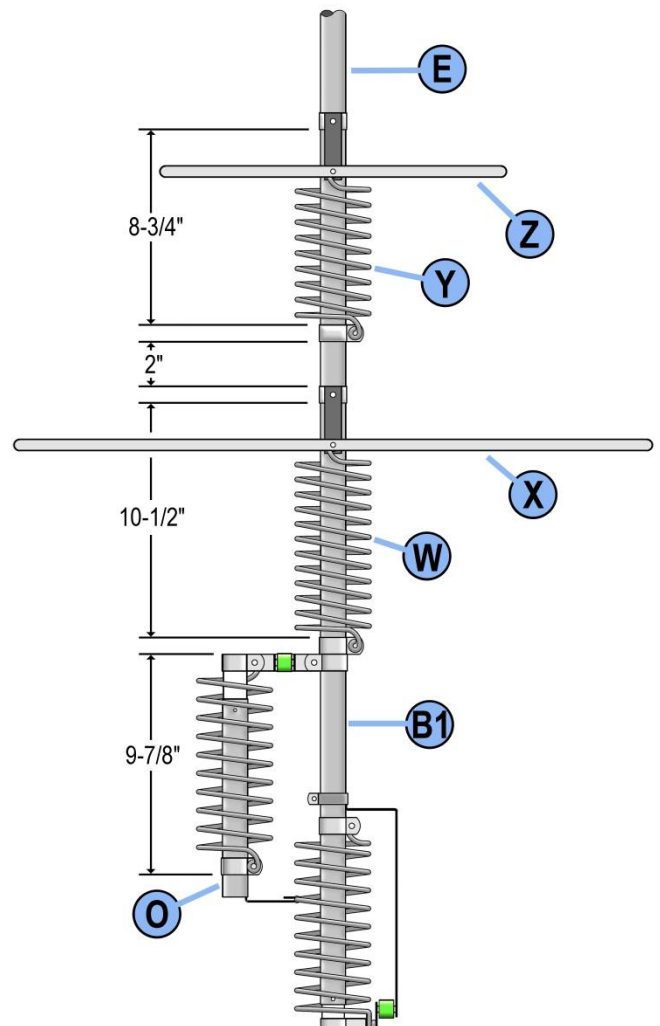
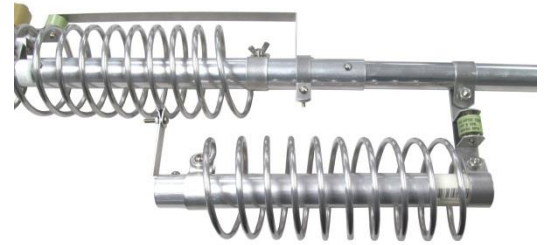

Steps 31 through 48 are for installing the 15 and 6 meter parts to the antenna. Use the following diagram to assist in identifying the parts and their proper locations:

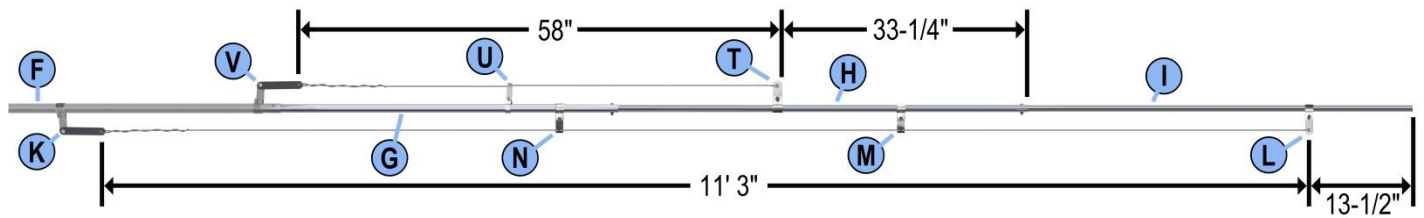

31. Position wire clamp 0.875" 15M with insulator (K) around tube (F) and use a # 8 x 1" screw, lock washer and hex nut. Tighten just finger tight. Final adjustment will be done in a later step.



32. Slide wire clamp 0.875" 6M with insulator (V) around tube (F).



33. Insert the un-slotted end of tube (G) into the slotted end of tube (F) and secure with a # 8 x 1 1/4" screw, lock washer and hex nut.



34. Position wire clamp 0.750" 6M with insulator (U) around tube (G).



35. Locate wire clamp 0.750" 15M with insulator (N) and position it around tube (G). Final tightening and positioning will be done in a later step.



36. Insert the un-slotted end of tube (H) into the slotted end of tube (G) and secure with a # 8 x 1" screw, lock washer and hex nut.



37. Position wire clamp 0.625" 6M with wire (T) around tube (H) so the top edge is 33-1/4" from the upper end of the tube.

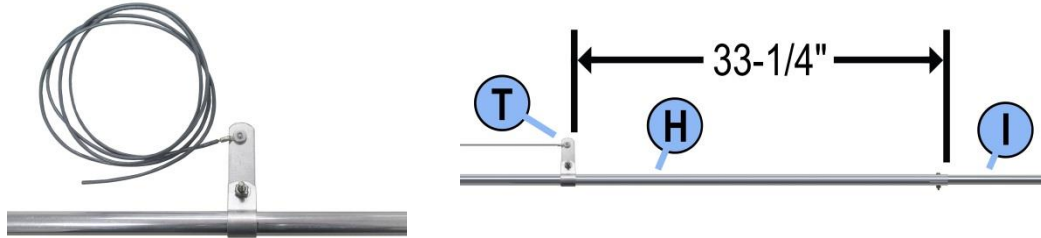

38. Pass the free end of the stranded wire from wire clamp 0.625" 6M with wire (T) through the small hole in wire clamp 0.750" 6M with insulator (U).

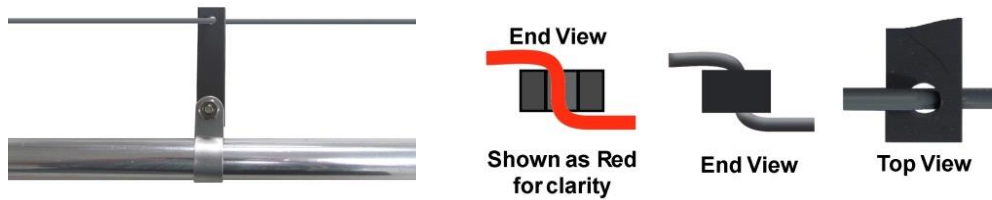

39. Line up and position the bottom edge of the 6M wire clamp 0.875" with insulator (V) 58" from the upper edge of the 6M wire clamp 0.625" with wire (T) and tighten.

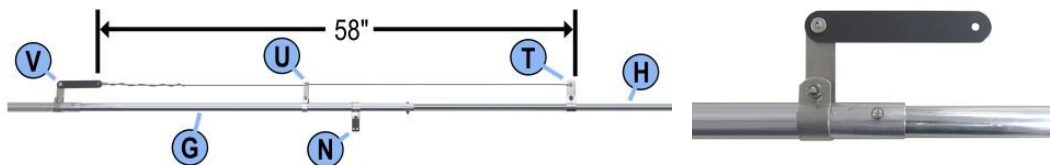

40. Pass the free end of the stranded wire from the 6M wire clamp 0.625" with wire (T) through the small hole in the 6M wire clamp 0.875" with insulator (V). Loop the free end of the wire around itself. Do not cut off the excess.



41. Center and align wire clamp 0.750" with insulator (U) and tighten.

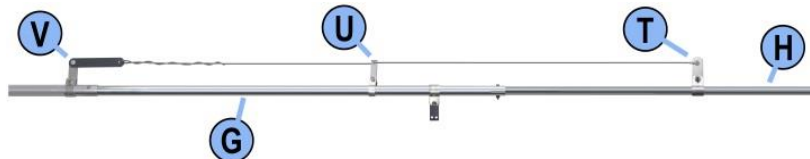

42. Locate the 15M wire clamp 0.625" with insulator (M) and position it around tube (H). Final tightening and positioning will be done in a later step.



43. Insert the un-slotted end of tube (I) into the slotted end of tube (H) and secure with a # 8 x 1" screw, lock washer and hex nut.



44. Position wire clamp 0.500" 15M with wire (L) around tube (I) so the top edge is 13-1/2 inches from the upper end of the tube and on the opposite side from the 6 meter assembly.

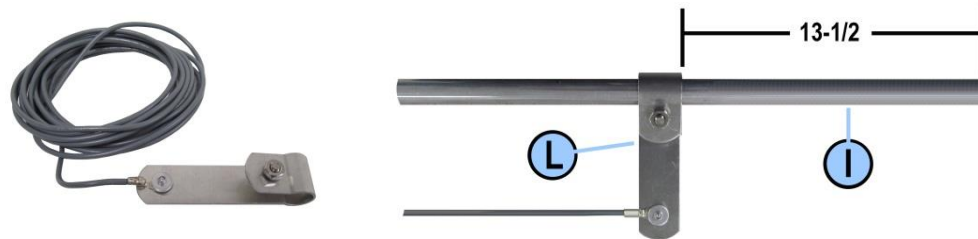

45. Measure from the rivet of wire clamp 0.500" 15M with wire (L) to a point 11 feet 3 inches along the stranded wire and mark this point.

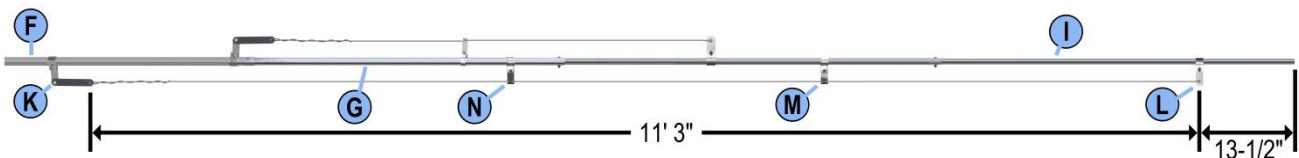

46. Pass the free end of the stranded wire from wire clamp 0.500" 15M with wire (L) through the small holes in wire clamp 0.625" 15M with insulator (M) and wire clamp 0.750" 15M w/insulator (N) as shown.

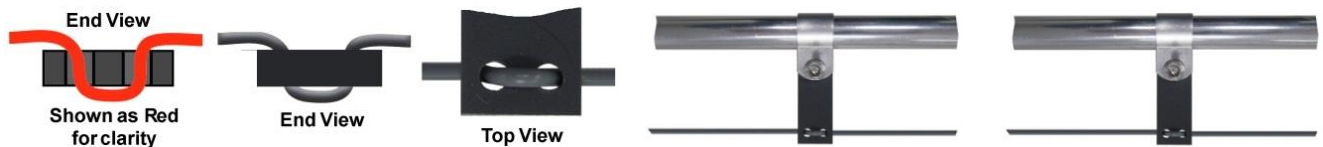

47. Loop the end of the wire through the hole in wire clamp 0.875" 15M with insulator (K) sliding it on tube (F) until the mark on the wire appears. Wind the wire back on itself. **Do not cut off the excess wire.**



48. Line up wire clamp 0.875" 15M with insulator (K), wire clamp 0.750" 15M with insulator (N) and wire clamp 0.625" 15M with insulator (M) with wire clamp 0.500" 15M with wire (L) and tighten all clamps making sure the wire is moderately taut but not enough to cause the upper tubing section to bow. Once tuning is complete, cover the end of the 15M and 6M wires with Scotch[®] Super 33+ tape to keep water from entering the wire.



49. Slide the uncapped end of tube (J) into the slotted end of tube (I) until 25 inches extends out from the end of tube (I) and secure with the small adjustable compression clamp (CC).

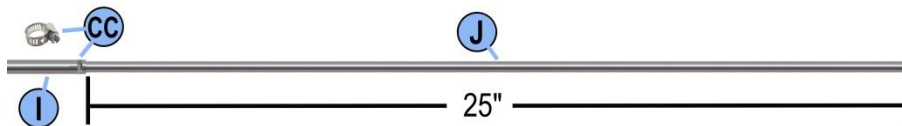

50. Place the protective cap (AA) on one end of tube (J).

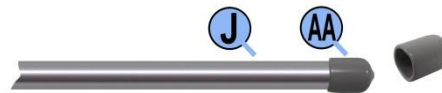

NOTE: In the following steps the antenna will be assembled and raised to its full vertical height. If the antenna is to be installed in an elevated position where it is unsafe or inconvenient to make in-place adjustments, the antenna may have to be installed in one piece. It will probably be necessary to raise and lower it and its supporting structure a number of times to arrive at the *ideal* adjustment on all bands. If so, every precaution should be observed in order to avoid possible contact with power lines and to prevent structural failure that can cause injury to persons or property.

WARNING: AVOID POWER LINES!

51. Place the lower end of tube (B) through tube (E) over the insulator on tube (A) with insulator. Line up the holes and secure it with a # 8 x 2" screw, lock washer and hex nut.
52. Raise the assembly of tube (F) through tube (J) and slide the lower end into tube (E) fastening it securely with a # 8 x 1-1/4" screw, lock washer and hex nut.
53. Install the 75 ohm matching coax (R) as shown placing the lug from the center conductor of the coax over the screw on tube (B) and the braid (ground side of coax) over the screw on tube with insulator (A). To aid in eliminating water damage of the coax, run it so the terminals are facing downward so water will drip down, not toward the coaxial cable.

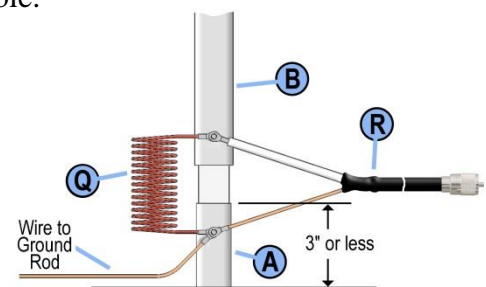

54. Place # 8 washers over each screw and install coil (Q) base matching. Secure with washers, lock washers and hex nuts.

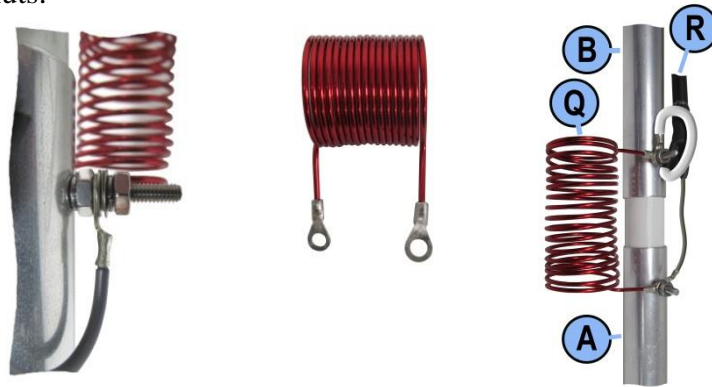

NOTE: Attach radials and ground to tube with insulator (A) using the remaining # 8 hardware on the ground side (lower side) of the coaxial cable connection.

WARNING: MAKE SURE THAT THE STATION EQUIPMENT IS CONNECTED TO A GOOD EARTH GROUND! DO NOT HANDLE CABLE CONNECTED TO STATION EQUIPMENT WITHOUT FIRST DISCONNECTING THE EQUIPMENT FROM THE POWER MAINS. YOU COULD BE ELECTROCUTED!

55. Connect the 75 ohm matching (R) coaxial cable with the included barrel connector (S) to any length of 50 to 53 ohm coaxial cable that goes to your transmitter.



Checkout and Adjustment

Adjustments **will** have to be made before trying to transmit with this antenna system. Installations vary considerably and there are no 'set' measurements that will work for all the variables in the installation. The dimensions and coil settings that were used during assembly are somewhat close and may produce reasonably low VSWR readings over the entire 10, 15, 20 and 30 meter bands and at least 250 kHz of the 40 meter band. Bandwidth on 80/75 meters should be at least 30 kHz for VSWR of 2:1 or less at the low end of the band and may be as much as 100 kHz at the high end of the band, **depending on the efficiency of the ground system used**, greater bandwidth being associated with lossy ground systems. It should be remembered that on those bands where the physical height of a vertical antenna is less than 1/4-wavelength, the earth (or the resonant radial system in above-ground installations) will have a good deal to do with VSWR and antenna tuning, bandwidth and overall performance.

Low VSWR by itself does not mean that a vertical antenna is operating efficiently, and if low VSWR is obtained with no more than the usual *quick and dirty* ground connection, it most likely means the opposite. In general, poor operation or improper tuning of vertical antennas can usually be attributed to inadequate (or even reactive) ground systems or to other vertical conductors in the vicinity of the antenna. For these reasons it is suggested that the antenna be placed as much in the clear as possible and used with the best ground system that conditions permit. For a more complete discussion of the interrelationships between vertical antenna efficiency, bandwidth, VSWR, etc., a standard text such as the *A.R.R.L. Antenna Book* is recommended.

For adjustment purposes a simple VSWR indicator may be used. More accurate measurements may be made at the antenna (i.e., at the junction of the coax 75 ohm matching (R) and the main transmission line) than at the input end of the line, but the tuning conditions that exist at the transmitter will usually be of greater interest in that one's principal concern will be to couple power from the transmitter into the transmission line.

1. Check VSWR on 10 meters. To raise the resonant frequency loosen the small clamp over the slotted end of tube (I) and slide tube (J) farther into tube (I). To lower the frequency, slide tube (J) farther out of tube (I) and retighten the small clamp. A length change of 3 inches should move the VSWR curve approximately 200 kHz.

NOTE: you can measure then adjust 15 and 10 meters at the same time since they don't interact like other band adjustment. This may help save some time and effort when tuning. The 12M coil MUST be compressed as much as possible upon initial tuning. If not, it is highly probable that 12M will actually be tuned into 10M throwing the ability to tune 10M at all.

2. Check VSWR on 15 meters. The VSWR curve may be shifted upward or downward by changing the length of the stranded wire between wire clamp 0.500" 15M with wire (L) and wire clamp 0.875" 15M with insulator (K).

To raise the frequency, simply shorten the wire by wrapping a longer *tail* back on itself and sliding the lower clamp upward to maintain tension. To lower frequency, feed more of the *tail* back through the hole in the insulator to increase the length of the wire between wire clamp

0.500" 15M with wire (L) and wire clamp 0.875" 15M with insulator (K). A change of 2 inches will shift the VSWR curve approximately 300 kHz.

Check VSWR on 6 meters. To raise the frequency of the lowest VSWR, shorten the length of the wire and to lower frequency increase the wire length. Alternatively, the upper clamp and the entire 6 meter assembly may be placed higher on the antenna to lower frequency or lower to raise it.

Note: 15M and 6M will interact with each other. Changing one band (15M or 6M) will effect the other band's tuning. You will have to make adjustments and check both bands until you are satisfied with the results.

3. Determine the frequency at which VSWR is lowest on 80/75 meters. The coil setting given earlier should produce resonance and lowest VSWR at approximately 3700 kHz.

To raise the frequency of resonance of the lowest VSWR, simply loosen the wing nut on the lower coil clamp of the coil assembly 80/40 meter (C) coil on tube (B) and stretch the coil a bit more. To lower the frequency, compress the coil. A One inch change in the setting of this coil will produce a frequency shift of approximately 125 kHz.

NOTE: Remember that the antenna tunes very sharply in this range and that high values of VSWR may be encountered only a few kHz either side of the lowest VSWR readings, so it would be well to take VSWR readings every 25 kHz or so to avoid *running past* the frequency of resonance and lowest VSWR.

NOTE: To minimize interference to other stations and to avoid erroneous reading use only enough power to produce full-scale deflection of the meter in the *forward* or *R.F. out* position.

4. Once the proper coil setting has been found for the desired band segment, coil (Q) base matching at the base of the antenna may be adjusted for even lower VSWR. If earth losses are moderate to high a good match may be possible if coil (Q) base matching is left fully compressed; if earth losses are low (as with an extensive radial system) coil (Q) base matching may have to be stretched to twice its compressed length or more for a good match. In any case, a single setting for coil (Q) base matching should suffice for operation over most of 80/75 meters provided the 80 meter coil is readjusted for each different band segment. Note that coil Q will have to be cut to remove turns and stretch the coil. The combination of cutting and stretching should be such to keep the dimensions of the coil reasonable and strong mechanically. Most installations will have to stretch and remove turns considerably. As you make the adjustments, check your VSWR, note that you CAN, and should get it down to 1:1.
5. Determine the frequency of minimum VSWR on 40 meters. The coil setting given earlier should produce resonance and lowest VSWR at approximately 7150 kHz. The 40 meter VSWR and resonance curve may be shifted in the same manner as on 80/75 meters by changing the setting of the upper coil clamp of coil assembly 80/40 meter. On this band the setting is much less critical, and a 1 inch change in the clamp setting will shift the VSWR curve approximately 80 kHz. Be sure to loosen the clamp around tube (E) that supports the 30 meter assembly and to reposition it as needed to avoid distorting the 40 meter coil.

6. Check VSWR on 20 meters. Tuning is quite broad on this band because the antenna is physically much taller than a 1/4-wavelength.

To raise the frequency of the lowest VSWR, reposition the 30 meter assembly so that the coil support tube 30 meter L bracket (O1) can be replaced on the next lower turn of the 40 meter coil. Alternatively, to lower the frequency of lowest SWR, reconnect the coil support tube 30 meter L bracket (O1) to the next higher turn of the 40 meter coil.

In some cases moving the tap point a full turn up or down may cause more of a frequency shift than is desired, in which case the entire 30 meter assembly may be rotated around tube (E) to permit adjustments of less than one full turn.

7. Check VSWR on 30 meters. To raise frequency, loosen the wing nut on the bottom coil clamp of coil/capacitor assembly 30 meter (P), stretch the coil and retighten the wing nut. To lower frequency, compress the coil.

A change of only 1/4 inch will shift the VSWR curve approximately 100 kHz. Large changes in the setting of coil/capacitor assembly 30 meter (P) may affect 20 and 40 meter tuning, in which case it may be necessary to repeat steps 5 and 6. In general, the point at which the 30 meter coil taps on to the 40 meter coil will be the major factor in 20 meter tuning.

8. Check VSWR on 17 meters. To move the SWR curve to a higher frequency loosen the wing nut on the upper coil clamp and STRETCH the coil about 1/16" at a time. To move the SWR curve to a lower frequency range COMPRESS the coil a like amount. 17M is a bit difficult to tune perfectly. Make small adjustments. A reading of 2.5:1 on 17 is normal.
9. Check VSWR on 12 meters. Stretch the 12 meter coil in increments of 1/16" or so to raise the resonant frequency, or compress the coil a like amount to lower the resonant frequency. Note: The 12M coil MUST be compressed as much as possible upon initial tuning. If not, it is highly probably that 12M will actually be tuned into 10M throwing the ability to tune 10M at all. 12M is very sensitive when making adjustments changes of 1/4" can cause your tuning to go out of band (high or low) - make small 1/16" adjustments.

10. Adjustments for 40, 30, 20, 15, 17, 12, 10 and 6 meters should have little or no effect on the previous adjustments for 80/75 meters, but a final VSWR check for this band should be made.

NOTE: In above-ground installations it will usually be found that resonance and lowest VSWR occur at slightly higher frequencies on all bands compared to ground-level installations. Therefore on 15 and 10 meters, where length adjustment is the means of getting antenna resonance, it is recommended that the length of the stranded-wire between wire clamp 0.500" 15M with wire (L) and wire clamp 0.875" 15M with insulator (K) be increased approximately 3" and that tube (J) be extended approximately 6" beyond the original dimensions given if any above-ground installation is contemplated. These are merely recommended preliminary settings, for it is impossible to indicate precise settings that will produce resonance or lowest VSWR at a given frequency in all installations.

In the preceding steps it has been assumed that the antenna has been installed in a more or less clear spot away from other vertical conductors such as TV antenna feedlines, towers and masts, and that a

minimal ground system (or a system of resonant radials in the case of above-ground installations) has been installed.

If those fairly basic conditions have not been met it is likely that resonance and low VSWR will be impossible on some or even all bands. One should bear in mind that VSWR, even with a resonant antenna, will depend in large measure on local ground conductivity, height above ground in the case of an elevated antenna, the extent of the radial, counterpoise or other ground system used, and on other factors over which the operator may have little or no control. Fortunately, the evils of VSWR greater than unity have been grossly exaggerated in recent decades, and the only practical difference between a VSWR of unity and one of, say, 3:1 in the average case lies in the reluctance of modern equipment to deliver full power into lines operating at the higher VSWR without the help of a transmatch or other outboard matching device.

Transmitters having so-called broadband solid-state output circuits (no tuning or loading controls) may be especially troublesome in this regard, whereas the older vacuum tube pi-network transmitters can usually be adjusted for maximum output over a tuning range where the VSWR does not exceed 2.5:1.

Above Ground (Elevated) Installations

The problem of ground loss resistance may be avoided to some extent by mounting a vertical antenna some distance above the earth over an artificial ground plane consisting of resonant (usually 1/4-wave) radial wires. Four resonant radials are considered to provide a very low-loss ground plane system for vertical antennas at base heights of 1/2-wave or more. This arrangement contrasts favorably with the more than 100 radials for zero ohms loss resistance at ground level, and since 1/2-wave is only about thirty-five feet at 20 meters, very worthwhile improvement in vertical antenna performance can be realized, at least on the higher bands, with moderate pole or tower heights. At base heights below 1/2-wave more than four radials will be required to provide a ground plane of significantly greater conductivity than the lossy earth immediately below the antenna: even so, a slightly elevated vertical with relatively few radials may be more effective than a ground-level vertical operating over a larger number of radials if only because the former is apt to be more in the clear. Resonant radial lengths for any band may be calculated from the formula:

$$\text{Length} = \frac{240}{\text{Frequency (MHz)}}$$

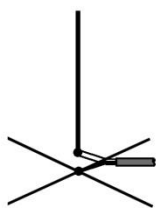

Elevated antennas may interact with the coaxial cable and cause RF feedback into the shack. It is recommended that a Feedline Current Choke (**DXE-FCC050-H05-A**) be installed at the base of the antenna near the feedpoint connection.

Figure 1 shows the basic ground plane system for elevated verticals. Radials may slope downward as much as 45 degrees without any significant effect on operation or performance. Radials for different bands should be separated as much as possible and the far end of each radial insulated from supporting wires.

Figure 2 shows a ground plane system that uses four resonant radials for 40 meters, another set of four for 20 meters, and a third set for 10 meters. A separate set for 15 meters is not ordinarily required because the 40 meter radials operate as resonant 3/4-wave radials on that band.

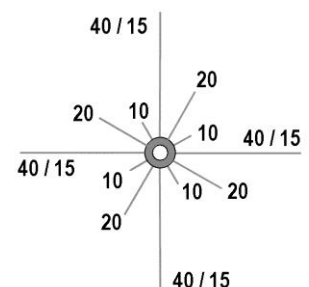

At the lower heights the separate wires of this system may provide enough capacitance to ground to permit low SWR operation on 80/75 meters as well, but

it is probable that at least one resonant radial will be required for low SWR on that band. It's important to note that cutting each conductor to a specific frequency will not work unless you separate it, angling each conductor away for most of its length because the longer ones will detune the shorter ones.

Above Ground Radial Systems

The 12-radial system of **Figure 2** is a very good one, but it requires at least 12 tie-off points. Butternut[®] has developed a multiband radial made of 300 ohm twinlead that resonates simultaneously on 40, 20, 15 and 10 meters. Four such radials offer essentially the same ground plane performance as the system of **Figure 2** but require only 4 supports. These multiband radials plus additional wire for an 80 meter radial are available separately (**BUT-STR-II**) or as part of the Butternut[®] roof mounting kit (**BUT-RMK-II**).

There are times when physical restrictions will dictate the use of fewer than four radials, and at least one manufacturer recommends 2 radials per band, the radials for each band running 180 degrees away from each other. A simpler (and no doubt less effective) system is shown in **Figure 3**. Since only one resonant radial is used per band the antenna will radiate both vertically and horizontally polarized energy, and the pattern will not be completely omnidirectional. For true ground plane action and predominantly vertical polarization no fewer than three equally-spaced radials should be used.

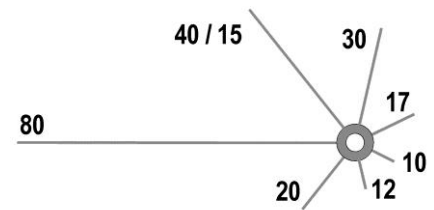

Figure 3

Figure 4 illustrates the construction of a multi-band radial which is resonant on 40, 20, 15 and 10 meters. Good quality 300 ohm TV ribbon lead should be used (velocity factor is critical), and the twinlead conductors should employ at least one strand of steel wire to support the weight of the radial.

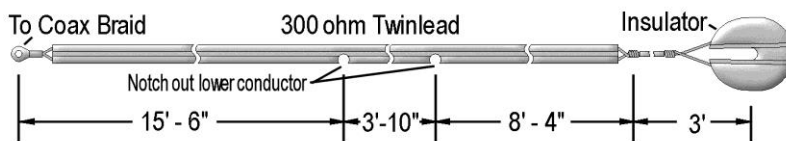

Figure 4

Four such radials will be the practical equivalent of the system shown in **Figure 2** for operation on 40 through 10 meters. Regardless of the number of radials used in either elevated or ground level systems, all radials should be attached to the ground connection at the antenna feedpoint by the shortest possible leads. An elaborate radial system at ground level, for example, cannot be used with a vertical antenna on a rooftop or on a tall tower, for the length of the ground lead would effectively become part of the antenna, thus detuning the system on most or all bands.

Metal Towers and Masts

If a metal mast or tower is used to support a vertical antenna all radials should be connected to the mast or tower at the ground connection of the antenna feedline. This is because one of the functions of a resonant radial is to detune a supporting metal structure for antenna currents that might otherwise flow on the structure and thus turn the vertical antenna system into a vertical long wire with unwanted high-angle radiation.

Other Mounting Schemes

In cases where a resonant vertical antenna may neither be ground mounted nor used with an elevated ground plane, operation may still be possible if connection can be made to a large mass of metal that is directly connected or capacitively coupled to the ground, e.g., central air conditioning systems or structural steel frames of apartment buildings. Some amateurs have reported good results with vertical antennas extended horizontally or semi-vertically from metal terraces which serve as

the ground connection. Alternatively, a 1/4-wave vertical may be window mounted if a short ground lead to a cold water pipe or radiator can be used. If a long lead must be used, tuned radials may be required for resonance on one or more bands. Great care should be exercised in such installations to avoid power lines and to keep the antenna from falling onto persons or property.

Mobile Home and Recreational Vehicle Installation

The principles of vertical antenna installations for use on mobile homes or RV's are the same as for other installations, and they all boil down to two main considerations. The first is that of erecting the vertical in the clearest possible spot, away from obstacles (including the MH or RV) that can interfere with radiation from the antenna. The second is that of installing the best possible ground system beneath the antenna in order to minimize losses from RF currents flowing in the earth below the antenna. Fortunately, the metal bodies of both Motor Homes and Recreational Vehicles can be used as highly conducting ground planes for vertical antennas in exactly the same way that auto bodies, etc., provide the ground system for shorter vertical antennas for mobile operation. The metal body of an automobile, Motor Home or Recreational Vehicle may be viewed as one plate of a capacitor. Since the surface area of even a small automobile is quite large and in close proximity to the earth, its body is tightly coupled to the earth below and may be considered simply as an extension of the earth itself - a kind of hill as far as radio frequencies are concerned, but one having higher conductivity than the earth itself. Recreational Vehicles and especially Motor Homes having much greater surface area will therefore provide a more extensive and effective ground system than a large number of radial wires occupying the same space as the Motor Home or Recreational Vehicle.

As in mobile installations, a vertical antenna may be mounted almost anywhere on the body of the vehicle or Motor Home and made to operate with reasonably low VSWR, but it is generally considered that the best possible location for a mobile antenna is in the middle of the roof of the vehicle, i.e., at the center of the vehicle's ground plane and at a point where the antenna will not be in the "shadow" of any part of the vehicle. It is not usually convenient, or even practical to install a relatively tall vertical on the roof of an Recreational Vehicle or Motor Home for any number of reasons, so the next best procedure would be to install a vertical antenna with its base at the same level as the roof, preferably near the middle of one of the longer sides. The exact way in which this may be done is a matter of convenience, but a short mast extending from ground level to the roof of the Motor Home and Recreational Vehicle and placed alongside the building or Recreational Vehicle would provide a stable and sturdy support with a minimum of mounting brackets and other modifications to the Recreational Vehicle or Motor Home. For portable operation such a mast could simply be lashed alongside the Recreational Vehicle with the base in a shallow hole in the ground for additional support, and there would be no harm in extending the mast a few inches above the roof level to permit attachment of ropes which could be used to hold the mast firmly against the side of the vehicle and to prevent side sway.

This system has been used successfully with various types of Recreational Vehicles, travel trailers and even passenger automobiles during portable operation. For "L" shaped mobile homes a vertical antenna should be placed in the corner of the "L" so that the metal roof will provide ground plane coverage over 270 degrees.

In all cases the base of the vertical antenna should not be more than a few inches away from the Motor Home or Recreational Vehicle so that the shortest possible lead may be run from the ground connection of the

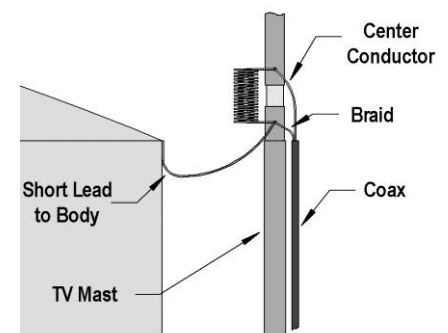

antenna to the metal body, as the length of this ground lead will effectively lengthen the antenna itself on all bands, and detuning can occur in some cases. A good electrical connection between the body of the Recreational Vehicle or Motor Home and the antenna is important, and in the case of mobile homes it would be a good idea to make sure that good electrical contact exists between the different parts of the metal body. Discontinuities can often lead to the production of harmonic radiation and TVI.

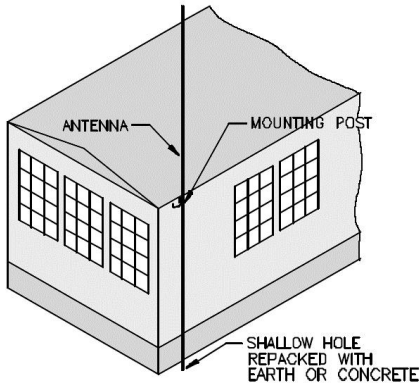

The essential circuit connections are shown in the diagram to the left. For permanent installations the bottom of the mast may be set deeper in the ground, and concrete may be used for greater strength and stability. The upper portion of the mast should be securely attached to the side of the building. Steel TV mast sections are readily available in lengths of ten feet and the mounting posts of Butternut[®] HF verticals will slide into those which have an outside diameter of 1-1/4 inches and a wall thickness of .058 inches. Other vertical antennas may use different mounting techniques and requirements, so be sure to select a mast that will be suited to the particular situation. The main point to keep in mind is that the mast should not extend more than a few

inches above the level of the roof so that the ground lead may be kept short.

Lightning Protection

Modern solid state amateur equipment is particularly vulnerable to damage from lightning or static induced transients that may appear on transmission lines.

Troubleshooting

Check out your installation again, looking for loose connections and checking all dimensions. Then refer to the list of possible symptoms below:

Symptom: Few or no signals heard: bands seem *dead*, SWR is very high.

Look for: Open or shorted feedline, open or shorted matching line, broken connection at base of antenna (feedpoint).

Symptom: High SWR on 20 meter; other bands OK.

Look for: Missing matching line. Antenna not properly tuned. 20 meter radials not present or wrong length. Consult instructions for tuning and radial information; install matching line *RG-11 75 ohm coax, 11 feet 4 inches if solid dielectric, 13 feet 6 inches if foam type*. Coax cable lengths used for the matching line will vary due to the velocity factor of the coax. You want the electrical length to be 1/4-wavelength.

Symptom: High SWR on some bands, but signals heard on all bands (conditions permitting).

Look for: Missing or defective radial system. Install as per instructions and check connections to radials and ground system. Keep this connection 6 inches or less.

Symptom: SWR on 15 meters seems to vary during a windy day.
Look for: This is normal since the 15 meter wire is side mounted and when the antenna sways, the distance between the 15 meter wire and main antenna will vary.

Symptom: SWR on 17 meters seems to be high compared to the other bands.
Look for: This is normal. 17 meters has always been difficult to tune. A VSWR of 2.5:1 is acceptable for 17 meters.

Symptom: High SWR on one band when antenna is roof-mounted. Radials are in place, but antenna will just not tune.
Look for: Radials of wrong length or running close to metal rain gutters or roof flashing. Tune radials and/or reroute them away from metal.

Symptom: Tuning is *sharp* with narrow bandwidth on 80 meter (and 160 meter if **BUT-TBR-160-S** is in place).
Look for: Normal condition. The total length of the antenna represents such a small percent of a wavelength on these bands that sharp tuning is a normal condition.

Symptom: Antenna was installed on the ground and tuned OK, but tuning changed over a period of weeks or months.
Look for: Antenna installed over poor ground system. Ground conditions have changed, causing shift in resonance. Install radial system as per instructions. Check connection to radial system. When you see this problem, you may assume that a ground rod without a radial system is not enough. Vertical antennas require a good radial wire system.

Symptom: Resonant point changes during wet or icy weather.
Look for: Normal condition.

Symptom: Insulation arcs over between 80 meter and 40 meter coils damaging fiberglass.
Look for: Operation at high power levels in areas where salt or pollution deposits have built up on the insulators. The cure is to keep insulators clean through routine maintenance.

Symptom: Intermittent operation. SWR jumps up and down suddenly, and reception is also intermittent.
Look for: Loose connections in the feedline or matching line (if used). Bad relay in rig. Bad antenna switch or connecting cable. Broken or corroded connections at the feedpoint. Bad radial/ground connection. Radial or antenna contacting metal when wind blows. Loose hardware on the antenna. Check and secure all connections.

Symptom: Antenna displays generally degraded performance after long period of time.
Look for: Lack of routine maintenance. Coax may be waterlogged or damaged. Build up of salt or pollution deposits on insulators and capacitors. Radial system corroded or rotted away. Owner must do routine maintenance at intervals, according to local conditions.

Symptom: SWR is OK on 75 meters, but goes up gradually when high power is applied. This is accompanied by heating of 200 pF capacitor.
Look for: Bad ceramic capacitor. Replace.

Symptom: Antenna doesn't tune 80 meter or 160 meter, even though radials are in place and of proper length.

Look for: Antenna far out of tune; operator has not followed systematic tuning procedure. Start with suggested settings in instructions. Make an SWR chart to determine point of resonance. Adjust coils *carefully!* Remember, tuning, is *sharp* on these bands, so it is easy to pass the resonant point, then assume erroneously that the antenna isn't tuning. BEFORE you call Butternut for help, please double check your installation, including all connections and dimensions. Tune carefully and systematically. Have SWR curves available. Be prepared to describe your installation in detail.

Guying the HF9V Antenna

The HF9V is designed to survive winds of up to 80 mph without guying in the absence of ice loading or heavy precipitation, but over a period of time it is to be expected that frequent or even constant flexing or vibration will reduce the chances for survival in winds that would not damage a newly installed antenna. Therefore in areas of frequent or heavy winds a set of short non-conductive guys should be used to reduce the stresses that wind loading will impart to the lower sections of the antenna.

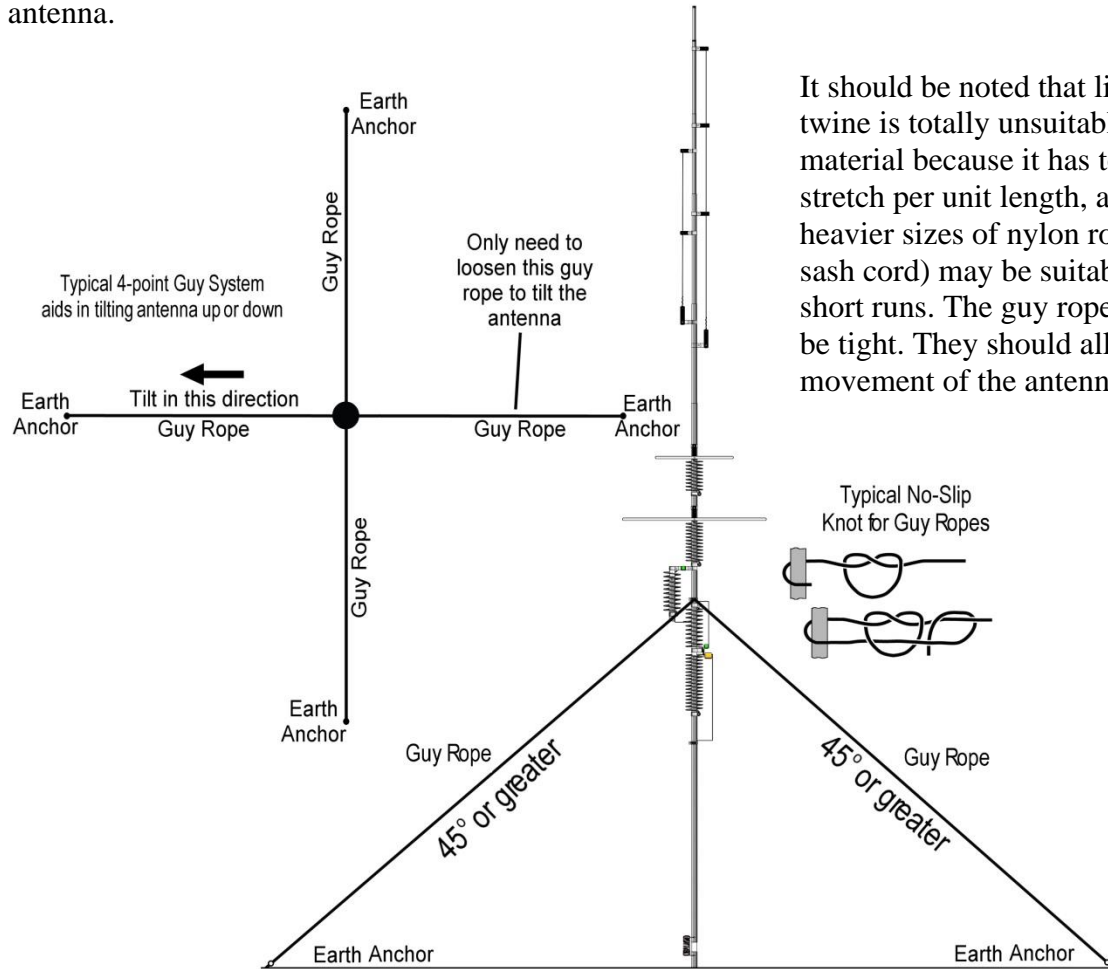

It should be noted that light nylon twine is totally unsuitable as guying material because it has too much stretch per unit length, although the heavier sizes of nylon rope (or even sash cord) may be suitable if used in short runs. The guy ropes should not be tight. They should allow for some movement of the antenna.

Synthetic Textile Industries Antenna Support Rope which is a premium double-braided Dacron/Polyester rope has been used for guying vertical antennas. A single set of guys placed just above the 30 meter circuit will contribute greatly to the stability and the longevity of the antenna, provided that the guys retain a slight amount of slack and do not come off at too steep an angle.

At angles of less than 45 degrees, the guys begin to exert a downward compressive force on the structure that can be more of a threat to survival than lateral wind loading on an un-guyed structure. Under no circumstances should guys be placed higher than one-third of the way up the antenna. The upper two-thirds of the HF9V has little more than its own weight to support, so these sections may be allowed to bend with the wind with no serious risk of damage. It is the lower third of the antenna that must support both the weight of the upper sections and the wind loading on them and are thus more likely to receive damage in severe winds.

Butternut[®] HF9V Parts List

Ref	Part Number	Description	Qty
A	00278SZV	Tube A with Insulator, 1-1/8" dia x 24" long	1
B	00115AV	Tube B element, 1-1/8" dia x 48" long	1
B1	00365SZV	Tube B1 with Insulator, 1-1/8" dia x 12" long	1
C	00145SV	Coil Assembly - 80/40 meters	1
D	BUT-290-07	Capacitor Assembly 80/40 meters	1
D1	00150BAV	Capacitor Bracket, Long, 80 meters	1
D2	00220BAV	Capacitor Bracket, Short, 40 meters	1
E	00123BAV	Tube E, 1" dia x 48" long	1
F	00124BAV	Tube F, 7/8" dia x 48" long	1
G	00125BAV	Tube G, 3/4" dia x 48" long	1
H	00126BAV	Tube H, 5/8" dia x 48" long	1
I	00127BAV	Tube I, 1/2" dia x 48" long	1
J	00175BAV	Tube J, 3/8" dia x 36" long	1
K	00286RZV	Wire Clamp, 7/8" with Insulator - 15 meters	1
L	00280RZV	Wire Clamp, 1/2" with Wire - 15 meters	1
M	00281RZV	Wire Clamp, 5/8" with Insulator - 15 meters	1
N	00282RZV	Wire Clamp, 3/4" with Insulator - 15 meters	1
O	00204SZV	Coil Support Tube with Insulator, 1-1/8" dia x 9" - 30 M	1
O1	00176BAV	Coil Tube Support "L" Bracket - 30 meters	1
P	00249SZV	Coil/Capacitor Assembly - 30 meters	1
Q	00137SZV	Coil Q Base, Matching	1
R	290-08	75 ohm Matching Coaxial Cable	1
S	00228GZV	Barrel Connector for PL-259 to PL-259	1

Ref	Part Number	Description	Qty
T	00331RZV	Wire Clamp, 5/8" with Wire - 6M	1
U	00332RZV	Wire Clamp, 3/4" with Insulator - 6M	1
V	00314RZV	Wire Clamp, 7/8" with Insulator - 6M	1
W	00503SZV	Coil Assembly - 17 meters A-17-12	1
X	00215BAV	Strip, Long - 17 meters	1
Y	00258SZV	Coil Assembly - 12 meters A-17-12	1
Z	00216BAV	Strip, Short - 12 meters	1
AA	00089FZV	Vinyl End Cap (Black or Grey)	1
BB	00143BAV	Capacitor Bracket Clamp	2
CC	00144JZV	Adjustable Element Clamp, Small	1
	00109	# 8-32 X 2" Long, Screw	2
	00114	# 8-32 X 1-1/2" Long, Screw	3
	00079	# 8-32 X 1-1/4" Long, Screw	3
	00078	# 8-32 X 1" Long, Screw	5
	00077	# 8-32 X 3/4" Long, Screw	3
	00080	# 8 Split Lock Washer	18
	00081	# 8-32 Hex Nut	18
	00083	# 8 Flat Washer	7
	00131	#10-24 X 1" Long, Screw	2
	00133	#10 Split Lock Washer	8
	00132	#10 Flat Washer	8
	00134	#10-24 Hex Nut	4
	00135	#10-24 Wing Nut	5

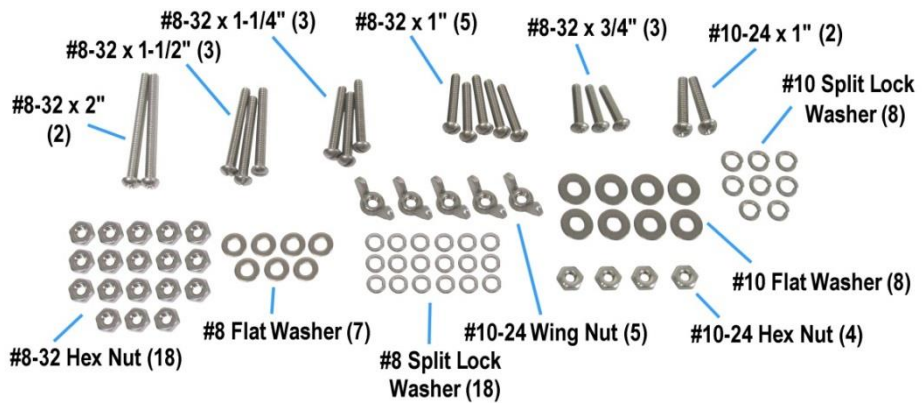
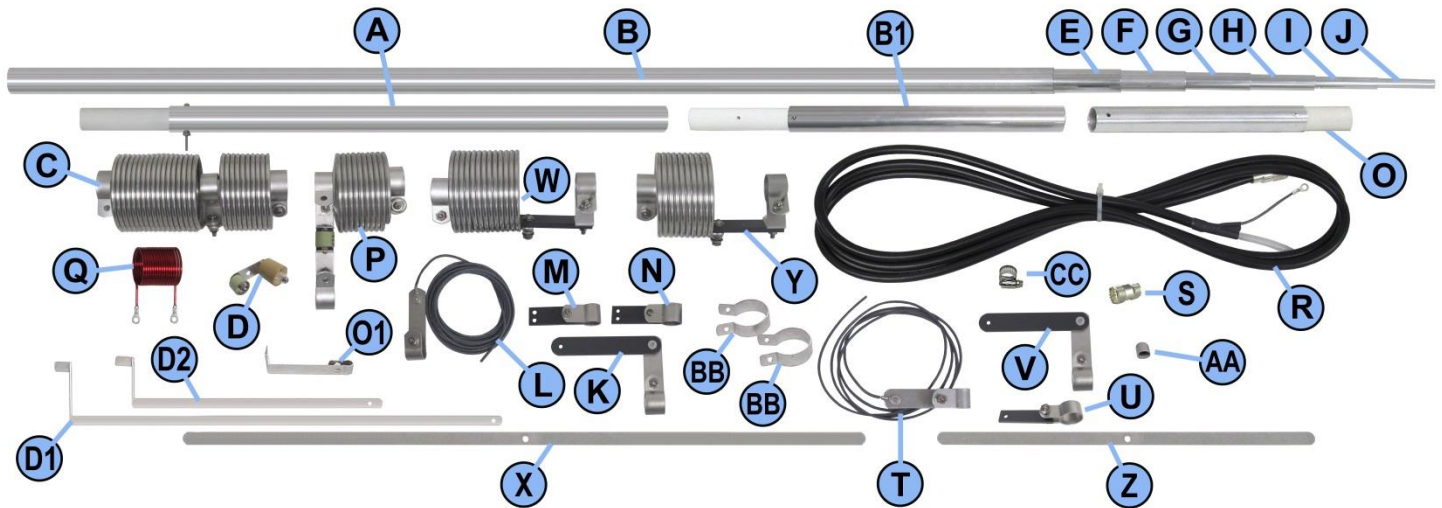

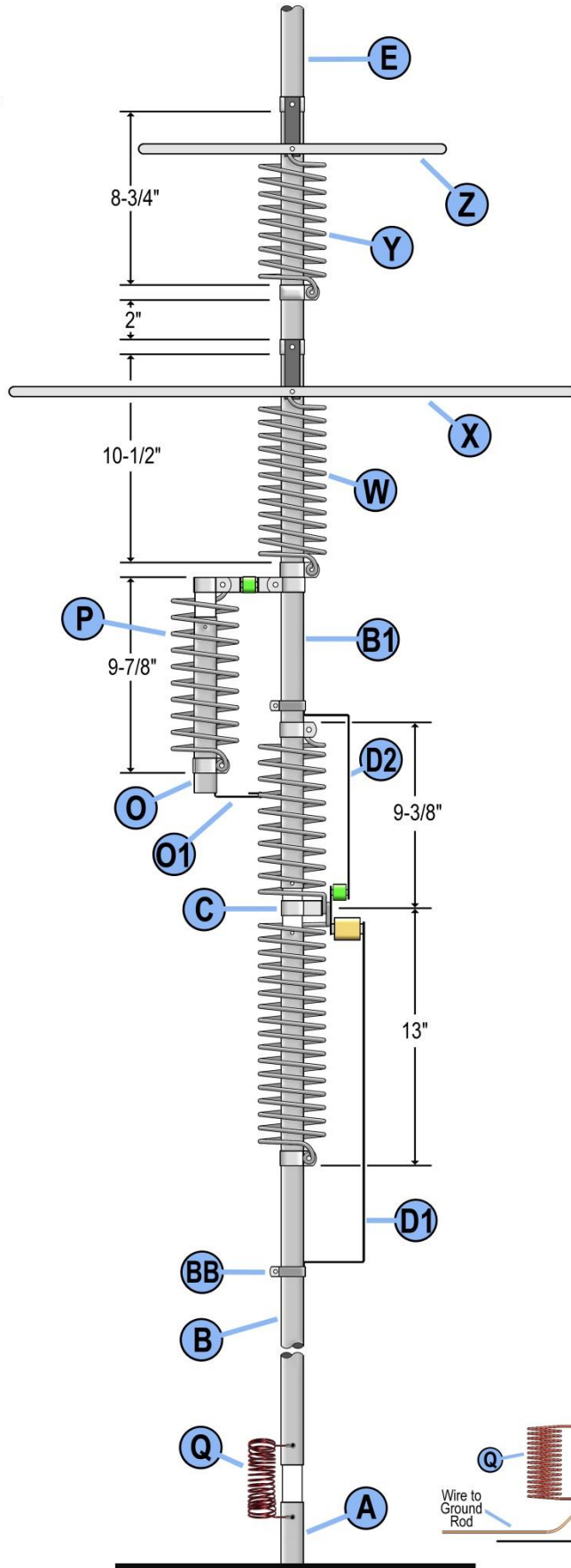
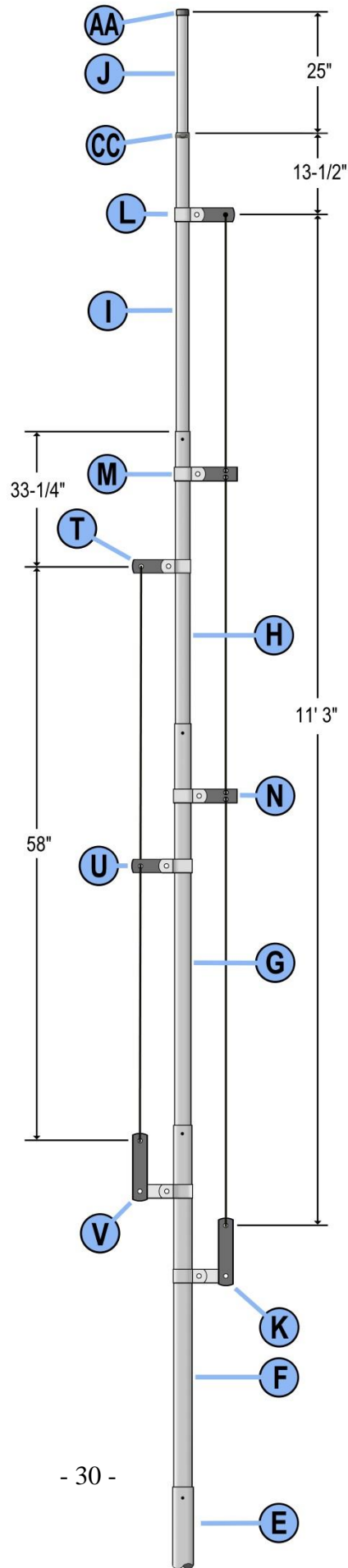

**HF9V Assembly
with Enlarged
Details**

[Dimension in inches.
Drawings not to scale.]

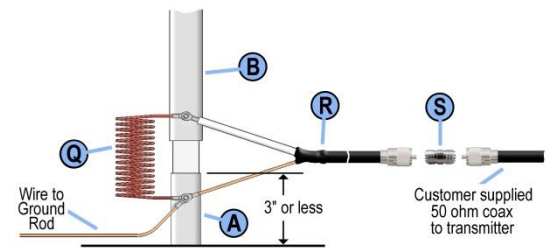

Technical Support

If you have questions about this product, or if you experience difficulties during the installation, contact Butternut at (330) 572-3200.

For best service, please take a few minutes to review this manual before you call.

Another great place for information about the classic Butternut® Antennas is the Butternut® Yahoo Group - <https://groups.yahoo.com/neo/groups/Butternut-antennas/info>

This special interest group is moderated by Scott Myers, AC8DE and contains a treasure trove of Butternut® antenna information from users around the world.

Warranty

All products manufactured by Butternut are warranted to be free from defects in material and workmanship for a period of one (1) year from date of shipment. Butternut's sole obligation under these warranties shall be to issue credit, repair or replace any item or part thereof which is proved to be other than as warranted; no allowance shall be made for any labor charges of Buyer for replacement of parts, adjustment or repairs, or any other work, unless such charges are authorized in advance by Butternut. If Butternut's products are claimed to be defective in material or workmanship, Butternut shall, upon prompt notice thereof, issue shipping instructions for return to Butternut (transportation-charges prepaid by Buyer). Every such claim for breach of these warranties shall be deemed to be waived by Buyer unless made in writing. The above warranties shall not extend to any products or parts thereof which have been subjected to any misuse or neglect, damaged by accident, rendered defective by reason of improper installation, damaged from severe weather including floods, or abnormal environmental conditions such as prolonged exposure to corrosives or power surges, or by the performance of repairs or alterations outside of our plant, and shall not apply to any goods or parts thereof furnished by Buyer or acquired from others at Buyer's specifications. In addition, Butternut's warranties do not extend to other equipment and parts manufactured by others except to the extent of the original manufacturer's warranty to Butternut. The obligations under the foregoing warranties are limited to the precise terms thereof. These warranties provide exclusive remedies, expressly in lieu of all other remedies including claims for special or consequential damages. SELLER NEITHER MAKES NOR ASSUMES ANY OTHER WARRANTY WHATSOEVER, WHETHER EXPRESS, STATUTORY, OR IMPLIED, INCLUDING WARRANTIES OF MERCHANTABILITY AND FITNESS, AND NO PERSON IS AUTHORIZED TO ASSUME FOR BUTTERNUT ANY OBLIGATION OR LIABILITY NOT STRICTLY IN ACCORDANCE WITH THE FOREGOING.

©Butternut 2016

Butternut®, SkyHawk™, SkyLark™, SecureMount™ are trademarks of PDS Electronics, Inc. No license to use or reproduce any of these trademarks or other trademarks is given or implied. All other brands and product names are the trademarks of their respective owners.

Specifications subject to change without notice.